

Z 121/...

Wärmeisolierplatte, eckig
 Thermal insulating sheet, rectangular
 Plaque isolante, carré

Mat.: Kunstharz/Glasfaser
 Synthetic resin/glass fibre
 Résine synth./fibre de verre

max. 230°C
 $\lambda = 0,21 \text{ W/mK}$

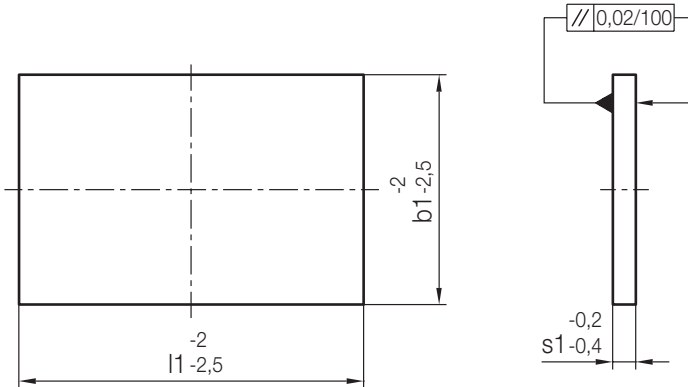
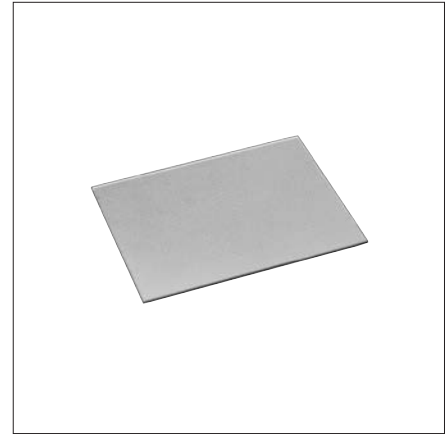

Sicherheitsdatenblatt
 Safety data sheet
 Fiche de données de sécurité

b1	l1	s1	Nr./No.
95	95	3	Z 121/095x 095x3
		5	5
100	130	3	Z 121/100x 130x3
		5	5
156	156	3	Z 121/156x 156x3
		5	5
	196	3	196x3
		5	5
		5	5
	246	3	246x3
		5	5
		5	296x5
5		346x5	
176	126	3	Z 121/176x 126x3
		5	5
	156	3	156x3
		5	5
		5	5
		5	5
190	246	3	Z 121/190x 246x3
		5	5
	296	296x5	
196	196	3	Z 121/196x 196x3
		5	5
	246	3	246x3
		5	5
	296	7	296x5
		7	7
	346	5	346x5
		7	7
	396	7	396x7
		7	7
	446	7	446x7
7		7	
496	7	496x7	
	7	7	
546	7	546x7	
	7	7	
206	156	3	Z 121/206x 156x3
		5	5

b1	l1	s1	Nr./No.	
206	196	3	Z 121/206x 196x 3	
		5	5	
218	246	5	Z 121/218x 246x 5	
		5	5	
	396	7	396x 7	
246	246	5	Z 121/246x 246x 5	
		7	7	
	296	5	296x 5	
		7	7	
	346	5	346x 5	
		7	7	
	396	5	396x 5	
		7	7	
	446	8,5	7	446x 7
			7	496x 8,5
7			546x 8,5	
7			596x 8,5	
7			7	
254	246	5	Z 121/254x 246x 5	
		7	7	
276	296	5	Z 121/276x 246x 5	
		7	296x 7	
296	296	7	Z 121/296x 296x 7	
		8,5	8,5	
		8,5	8,5	
	346	7	7	346x 7
			8,5	8,5
	396	7	7	396x 7
			8,5	8,5
	446	8,5	7	446x 7
			7	496x 8,5
			7	546x 8,5
			7	596x 8,5
			7	646x 8,5
			7	696x 8,5
7			7	
7			7	
346	346	7	Z 121/346x 346x 7	
		8,5	8,5	

Z 121/...

Wärmeisolerplatte, eckig
 Thermal insulating sheet, rectangular
 Plaque isolante, carré

Mat.: Kunstharz/Glasfaser
 Synthetic resin/glass fibre
 Résine synth./ fibre de verre

max. 230°C
 $\lambda = 0,21 \text{ W/mK}$

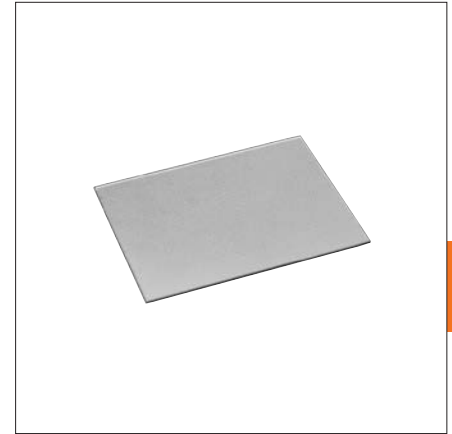
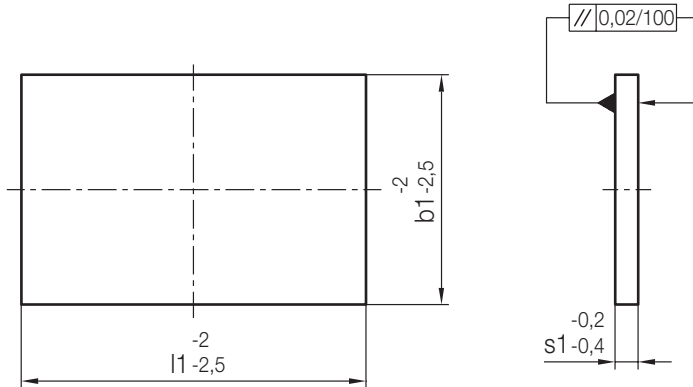

2

Sicherheitsdatenblatt
 Safety data sheet
 Fiche de données de sécurité

b1	l1	s1	Nr./No.	b1	l1	s1	Nr./No.
346	396	7	Z 121/346x 396x 7	546	696	8,5	Z 121/546x 696x 8,5
		8,5	8,5				796x 8,5
	446	446x 8,5	896x 8,5				
		496	7				Z 121/346x 496x 7
	8,5		8,5		596		596
	546x 8,5	546x 8,5	646x 8,5				
	596x 8,5	596x 8,5	696x 8,5				
	696x 8,5	696x 8,5	796x 8,5				
	646x 8,5	646x 8,5	896x 8,5				
	796x 8,5	796x 8,5	996x 8,5				
396	396	7	Z 121/396x 396x 7	646	596	Z 121/646x 596x 8,5	
		8,5	8,5		646x 8,5		
	446	7	446x 7		696x 8,5		
		8,5	8,5		746x 8,5		
	496	7	496x 8,5		796x 8,5		
		8,5	8,5		896x 8,5		
	546	7	546x 7		996x 8,5		
		8,5	8,5		696	696	Z 121/696x 696x 8,5
	596x 8,5	596x 8,5	746x 8,5				
	646x 8,5	646x 8,5	796x 8,5				
	696x 8,5	696x 8,5	896x 8,5				
	796x 8,5	796x 8,5	896x 8,5				
	896x 8,5	896x 8,5	996x 8,5				
	446	446	Z 121/446x 446x 8,5		746	796	Z 121/746x 796x 8,5
546x 8,5			896x 8,5				
596x 8,5		596x 8,5					
646x 8,5		646x 8,5	796	796	Z 121/796x 796x 8,5		
696x 8,5		696x 8,5		846x 8,5			
796x 8,5		796x 8,5		896x 8,5			
896x 8,5		896x 8,5	996x 8,5				
496		646	Z 121/496x 646x 8,5	846	896	Z 121/846x 896x 8,5	
546	546	Z 121/546x 546x 8,5	996x 8,5				
	596x 8,5	596x 8,5	896	896	Z 121/896x 896x 8,5		
	646x 8,5	646x 8,5		996x 8,5			

Z 121/...

Wärmeisolerplatte, eckig, mit Zentrierflanschbohrung
 Thermal insulating sheet, rectangular, with hole
 Plaque isolante, carré, avec perçage pour rondelle de centrage

Mat.: Kunstharz/Glasfaser
 Synthetic resin/glass fibre
 Résine synth./fibre de verre

max. 230°C
 $\lambda = 0,21 \text{ W/mK}$

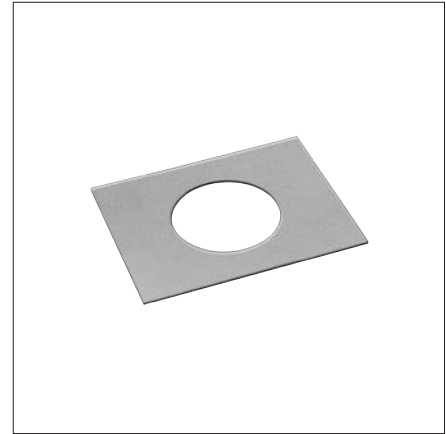
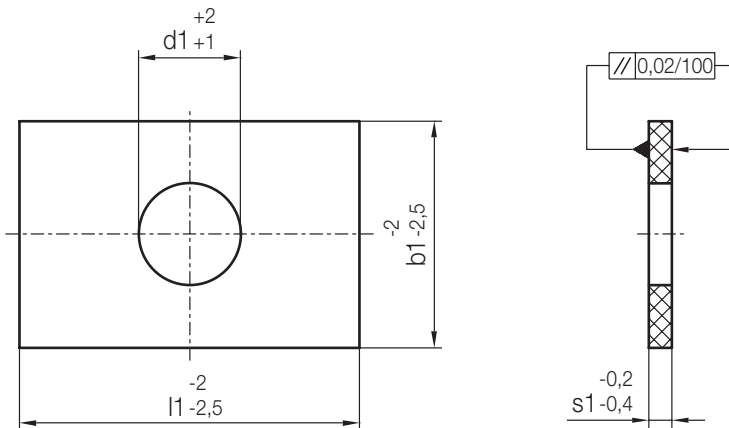

Sicherheitsdatenblatt
 Safety data sheet
 Fiche de données de sécurité

b1	l1	s1	d1	Nr./No.
95	95	3	22	Z 121/095x 095x3x22
		5		095x5
100	130	3	22	Z 121/100x 130x3
		5		130x5
156	156	3	90	Z 121/156x 156x3x90
		5		156x5
	196	3		196x3
		5		196x5
	246	3		246x3
		5		246x5
	296			296x5
	346			346x5
	396			396x5
176	126	3	90	Z 121/176x 126x3x90
		5		126x5
	156	3		156x3
		5		156x5
190	246	3	90	Z 121/190x 246x3x90
		5		246x5
	296			296/5
196	196	3	90	Z 121/196x 196x3x90
		5		196x5
	246	3		246x3
		5		246x5
	296			296x5
		7		296x7
	346	5		346x5
		7		346x7
	396			396x7
	446			446x7
	496			Z 121/196x 496x7x90
546		546x7		

b1	l1	s1	d1	Nr./No.	
206	156	3	90	Z 121/206x 156x3 x90	
		5		156x5	
		196		3	196x3
5	196x5				
218	246		90	Z 121/218x 246x5 x90	
		296		296x5	
		396		396x7	
246	246	5	90	Z 121/246x 246x5 x90	
		7		246x7	
	296	5		296x5	
		7		296x7	
	346	5		346x5	
		7		346x7	
	396	246		5	396x5
				7	396x7
446			8,5	446x8,5	
	546		546x8,5		
			596x8,5		
254	246	5	90	Z 121/254x 246x5 x90	
		7		246x7	
		276		5	Z 121/276x 246x5 x90
296	7		296x7		
296			90	Z 121/296x 296x7 x90	
		8,5		296x8,5	
	346	7		346x7	
		8,5		346x8,5	
	396	7		396x7	
		8,5		396x8,5	
	446			446x8,5	
	496			496x8,5	
	546			546x8,5	

Z 121/...

Wärmeisolerplatte, eckig, mit Zentrierflanschbohrung
 Thermal insulating sheet, rectangular, with hole
 Plaque isolante, carré, avec perçage pour rondelle de centrage

Mat.: Kunstharz/Glasfaser
 Synthetic resin/glass fibre
 Résine synth./ fibre de verre

max. 230°C
 $\lambda = 0,21 \text{ W/mK}$

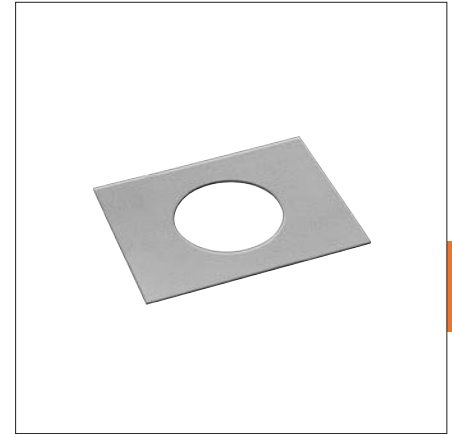
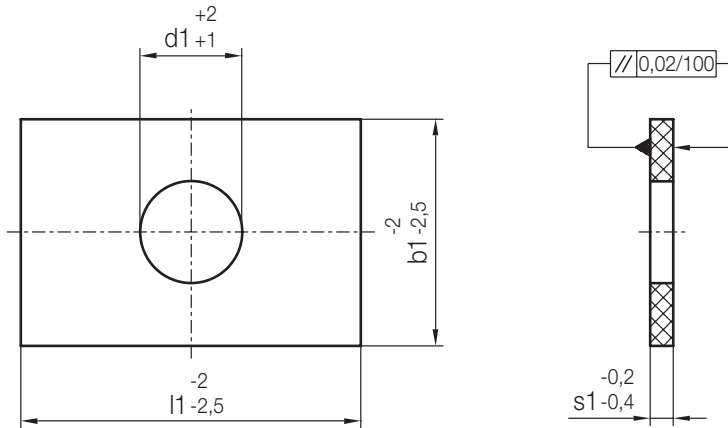

2

Sicherheitsdatenblatt
 Safety data sheet
 Fiche de données de sécurité

b1	l1	s1	d1	Nr./No.	
296	596	8,5	90	Z 121/296 x 596 x 8,5 x 90	
	646			646 x 8,5	
	696			696 x 8,5	
346	346	7	90	Z 121/346 x 346 x 7 x 90	
		8,5		346 x 8,5	
	396	7		396 x 7	
		8,5		396 x 8,5	
	446	446 x 8,5			
	496	496		7	Z 121/346 x 496 x 7 x 90
				8,5	496 x 8,5
		546		546 x 8,5	
		596		596 x 8,5	
		646		646 x 8,5	
396	396	7	90	Z 121/396 x 396 x 7 x 90	
		8,5		396 x 8,5	
	446	7		446 x 7	
		8,5		446 x 8,5	
	496	7		496 x 7	
		8,5		496 x 8,5	
		546		546 x 7	
	596	546		7	546 x 7
				8,5	546 x 8,5
		596		596 x 8,5	
		646		646 x 8,5	
		696		696 x 8,5	
		796		796 x 8,5	
896		896 x 8,5			
646		646 x 8,5			
446	446	8,5	90	Z 121/446 x 446 x 8,5 x 90	
				496	496 x 8,5
				546	546 x 8,5
				596	596 x 8,5
				646	646 x 8,5
				646	646 x 8,5

b1	l1	s1	d1	Nr./No.					
446	696	8,5	90	Z 121/446 x 696 x 8,5 x 90					
				796	796 x 8,5				
				896	896 x 8,5				
				896	896 x 8,5				
496	496	7	90	Z 121/496 x 496 x 8,5 x 90					
				546	546 x 7				
	546			546	8,5	546 x 8,5			
						596	596 x 8,5		
						646	646 x 8,5		
						696	696 x 8,5		
						796	796 x 8,5		
						896	896 x 8,5		
						996	996 x 8,5		
	546			546	8,5	90	Z 121/546 x 546 x 8,5 x 90		
							596	596 x 8,5	
646		646 x 8,5							
696		696 x 8,5							
796		796 x 8,5							
896		896 x 8,5							
996		996 x 8,5							
596		596	8,5				90	Z 121/596 x 596 x 8,5 x 90	
								646	646 x 8,5
								696	696 x 8,5
	796			796 x 8,5					
	896			896 x 8,5					
	996			996 x 8,5					
	646			596	8,5	90		Z 121/646 x 596 x 8,5 x 90	
								646	646 x 8,5
696		696 x 8,5							
696		696 x 8,5							

Z 121/...

Wärmeisolerplatte, rund
 Thermal insulating sheet, round
 Plaque isolante, ronde

Mat.: Kunstharz/Glasfaser
 Synthetic resin/glass fibre
 Résine synth./fibre de verre

max. 230°C
 $\lambda = 0,21 \text{ W/mK}$

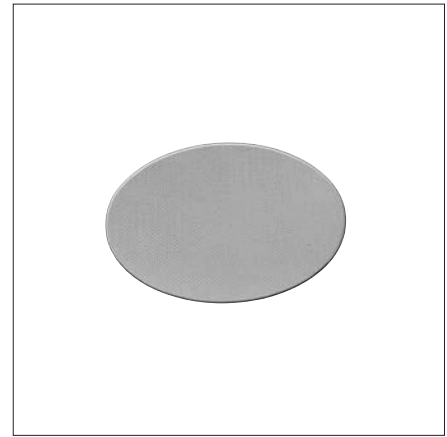

Sicherheitsdatenblatt
 Safety data sheet
 Fiche de données de sécurité

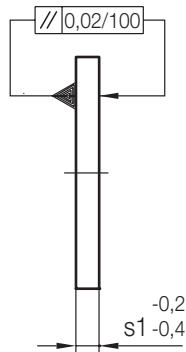
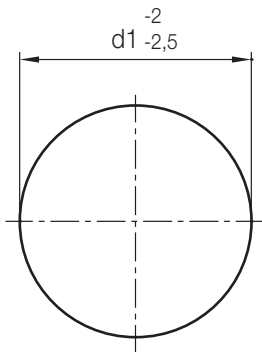

d1	s1	Nr./No.
095	3	Z 121/095x3
116		116x3
156		156x3
	5	156x5
196		196x5
246		246x5
296		296x5
344	7	344x7

Z 121/...

Wärmeisolerplatte, rund, mit Zentrierflanschbohrung
 Thermal insulating sheet, round, with hole
 Plaque isolante, ronde, avec perçage pour rondelle de centrage

Mat.: Kunstharz/Glasfaser
 Synthetic resin/glass fibre
 Résine synth./fibre de verre

max. 230°C
 $\lambda = 0,21 \text{ W/mK}$

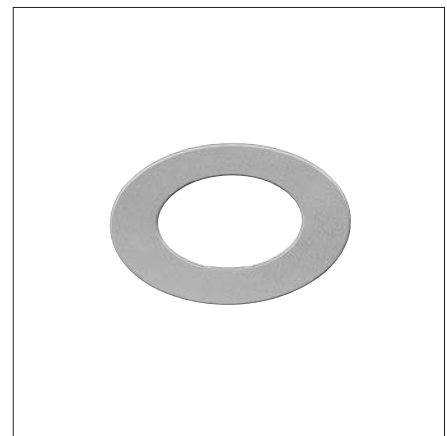

Sicherheitsdatenblatt
 Safety data sheet
 Fiche de données de sécurité

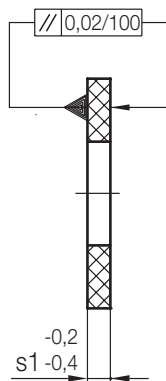
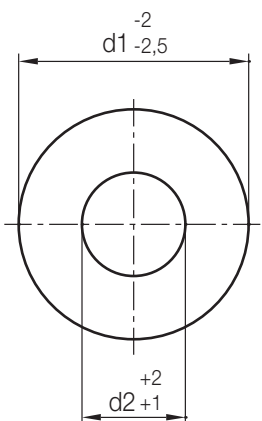

d1	s1	d2	Nr./No.
095	3	22	Z 121/095x3x22
156	3	90	156x3x90
	5		156x5x90
196			196x5x90
246			246x5x90
296			296x5x90
344	7		344x7x90

Firma/Company/Société: _____

Zuständig/Contact/Responsable: _____

Tel.: _____ Fax: _____

E-mail: _____ Datum/Date: _____

Bestellung/Order/Commande Nr./No.: _____ Anfrage/Quotation/Demande

Z 121/.../S
Z 1212/.../S

Wärmeisolerplatte
Thermal insulating sheet
Plaque d'isolation thermique

Toleranzbereich tolerance range zone de tolérance	b1 max.	l1 max.	s1 *	Druckfestigkeitsqualität Compressive strength quality Qualité de résistance à la compression	
				Z 121/.../S	Z 1212/.../S
+/- 0,15 mm	1200	2400	1-35	600 N/mm ²	420 N/mm ²

* abhängig von Plattengröße
depending on plate size
selon la grandeur de plaque



Stck./Pc.	Typ	b1	l1	s1	S	Beschichtung/coating/revêtement			
	Z 121 /	x	x	/	S	<input type="checkbox"/>	ja/yes/oui	<input type="checkbox"/>	nein/no/non
	/	x	x	/	S	<input type="checkbox"/>		<input type="checkbox"/>	
	Z 1212 /	x	x	/	S	<input type="checkbox"/>	ja/yes/oui	<input type="checkbox"/>	nein/no/non
	/	x	x	/	S	<input type="checkbox"/>		<input type="checkbox"/>	

Bitte Skizze/Zeichnung beifügen.

Please enclose diagram/drawing.

Veillez joindre un croquis/dessin.

Bearbeitungsdaten:

Machining data:

Données d'usinage:

3D step, Parasolid, 2D DXF oder DWG

3D step, Parasolid, 2D DXF or DWG

3D step, Parasolid, 2D DXF ou DWG

Senden Sie Ihre Anfrage bitte an:

Please send your quotation to:

Merci d'envoyer votre demande à:

Fax: 02351 957-320 oder/or/ou **Email: sonderanfertigungen@hasco.com**