

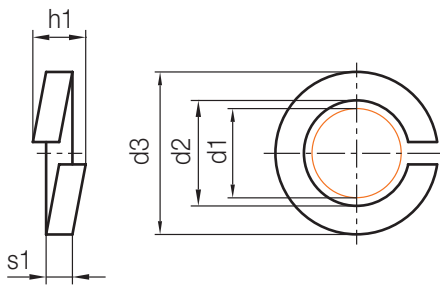

Z69/...

Federring
Spring washer
Rondelle Belleville

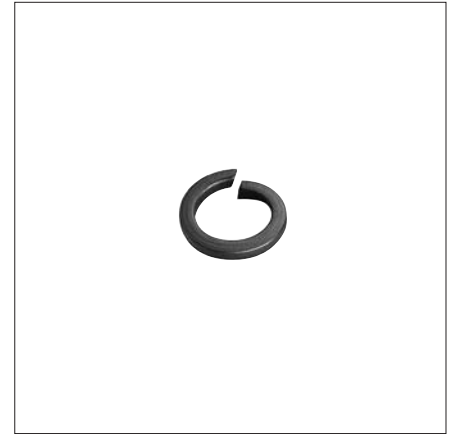

	h1	d3	d2	d1	s1	Nr./No.
10	2,8	7	4,1	4	1,2	Z69/ 4x1,2
	3,8	8,8	5,1	5	1,6	5x1,6
		9,9	6,1	6		6x1,6
	4,7	12,7	8,1	8	2	8x2
	5,9	16	10,2	10	2,5	10x2,5

	h1	d3	d2	d1	s1	Nr./No.
10	5,9	18	12,2	12	2,5	Z69/ 12x2,5
	8,3	24,4	16,2	16	3,5	16x3,5
		10,6	30,6	20,2	20	4,5
	11,8	35,9	24,2	24	5	24x5

Z691/...

Sperrkantring
Locking edge washer
Rondelle de sécurité

Mat.: DIN 17221

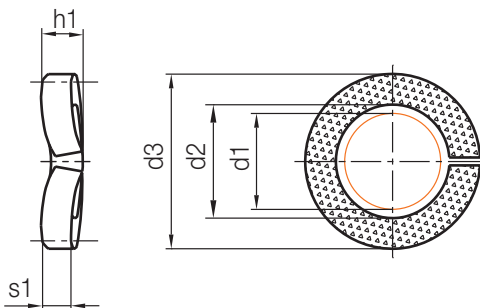
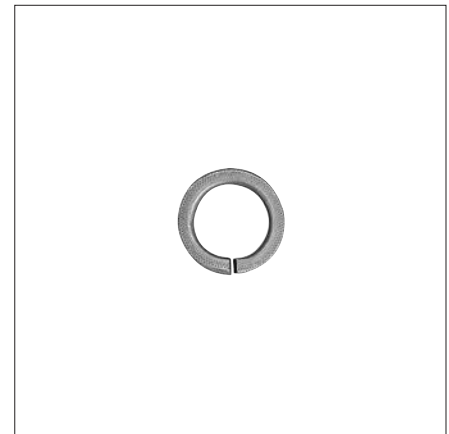

	h1	d3	d2	d1	s1	Nr./No.
10	2	7	4,1	4	1,2	Z691/ 4x1,2
	2,4	8,8	5,1	5	1,6	5x1,6
		9,9	6,1	6		6x1,6
	3,2	12,7	8,1	8	2	8x2
	4,1	16,1	10,2	10	2,5	10x2,5

	h1	d3	d2	d1	s1	Nr./No.
10	4,1	18,3	12,2	12	2,5	Z691/ 12x2,5
	5	21,4	14,2	14	3	14x3
		5,9	24,6	16,2	16	3,5
	7,3	30,6	20,2	20	4,5	20x4,5