

# Z801HT/...

Schnellkupplung, mit freiem Durchgang  
 Rapid coupling, open flow  
 Coupleur rapide, à passage ouvert

Mat.: 2.0401

Z81/...  
 Z83/...  
 Z830/...  
 Z831/...  
 Z90/...

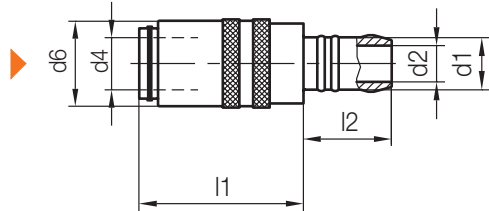

Z852/...  
 Z853/...  
 Z854/...



Medium	max. C°
Luft/air/air	220
Öl/oil/huile	220
Wasser/water/eau	180



Schlauchgrenzwerte können abweichen!  
 Hose limits can differ!  
 Les valeurs limites des tuyaux peuvent différer!



p [bar]	l2	l1	d6	d4	d2	d1	Nr./No.
25	22	31	17	9	6	<b>9</b>	Z801HT/ 9
	25	37	22	13	9	<b>13</b>	13

# Z801HT/...x45

Schnellkupplung, mit freiem Durchgang, 45° abgewinkelt  
 Rapid coupling, open flow, 45° angled  
 Coupleur rapide, à passage ouvert, coudé à 45°

Mat.: 2.0401

Z81/...  
 Z83/...  
 Z830/...  
 Z831/...  
 Z90/...

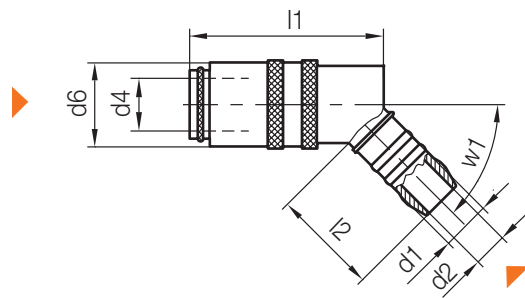

Z852/...  
 Z853/...  
 Z854/...



Medium	max. C°
Luft/air/air	220
Öl/oil/huile	220
Wasser/water/eau	180



Schlauchgrenzwerte können abweichen!  
 Hose limits can differ!  
 Les valeurs limites des tuyaux peuvent différer!



p [bar]	l2	l1	d6	d4	d2	d1	w1	Nr./No.
25	28	41	17	9	6	<b>9</b>	<b>45°</b>	Z801HT/ 9x45
		51	22	13	9	<b>13</b>		13

# Z801HT/...x90

Schnellkupplung, mit freiem Durchgang, 90° abgewinkelt  
 Rapid coupling, open flow, 90° angled  
 Coupleur rapide, à passage ouvert, coudé à 90°

Mat.: 2.0401

Z81/...  
 Z83/...  
 Z830/...  
 Z831/...  
 Z90/...

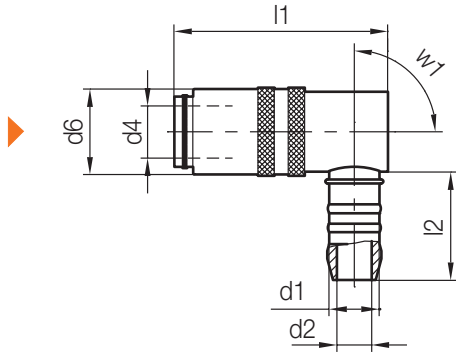

Z852/...  
 Z853/...  
 Z854/...



Medium	max. C°
Luft/air/air	220
Öl/oil/huile	220
Wasser/water/eau	180



Schlauchgrenzwerte können abweichen!  
 Hose limits can differ!  
 Les valeurs limites des tuyaux peuvent différer!



p [bar]	l2	l1	d6	d4	d2	d1	w1	Nr./No.
25	24	41	17	9	6	9	90°	Z801HT/ 9x90
	28	51	22	13	9	13		13